

Article number: 203380M20151B1W

Description: E+G levelling foot
GN 33-80-M20-151-B1-W, Stainless steel

Note: W With adjustable sleeve , Hygienic Version, Wrench flat at the bottom

Measures

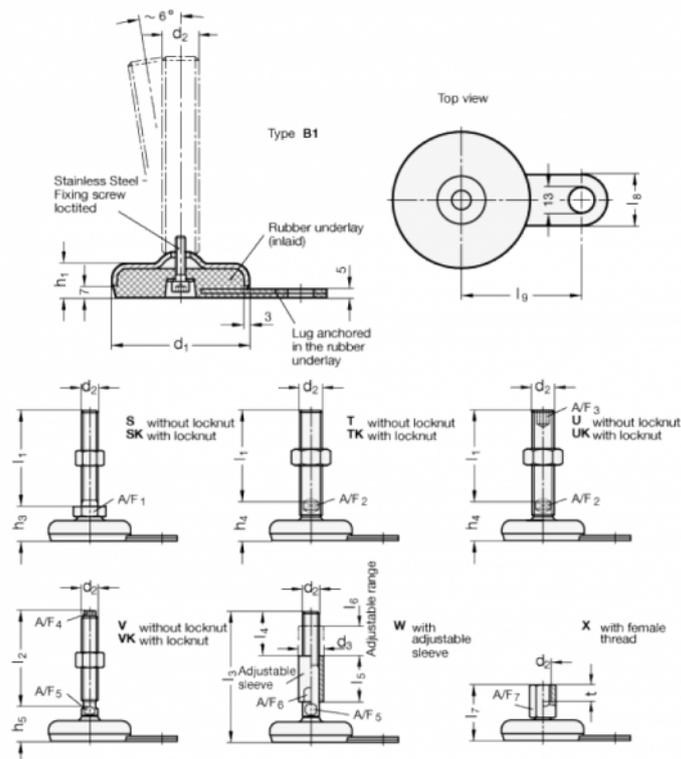

A/F5 = 16	I5 = 56
A/F6 = 24	I6 = 36
d1 = 80	I8 = 30
d2 = M20	I9 = 70
d3 = 30	
h1 = 20	
h2 = 56	
I3 = 151	